







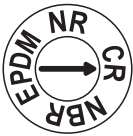

Especificações técnicas turbinas originais Liverani

Material		
		NBR Nitrile Nitrile
		CR Neoprene Neoprene rubber
		EPDM EPDM EPDM
		NR Gomma naturale Natural rubber
		VMQ Silicone Silicon

Modelo bomba	Cod. Turbina
MINI 3/4"	n.d. / n.a.
MIDEX 1"1/4	3173007
MINOR 40	3174007
MAJOR 60	3176007
MAXI 80	3178007

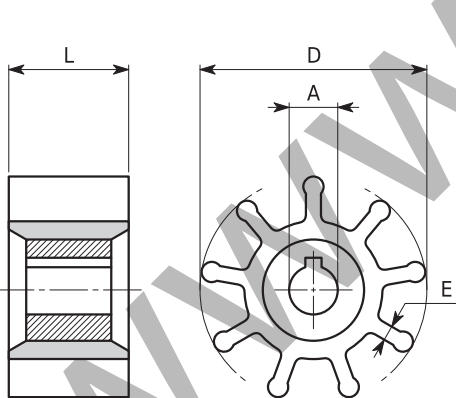
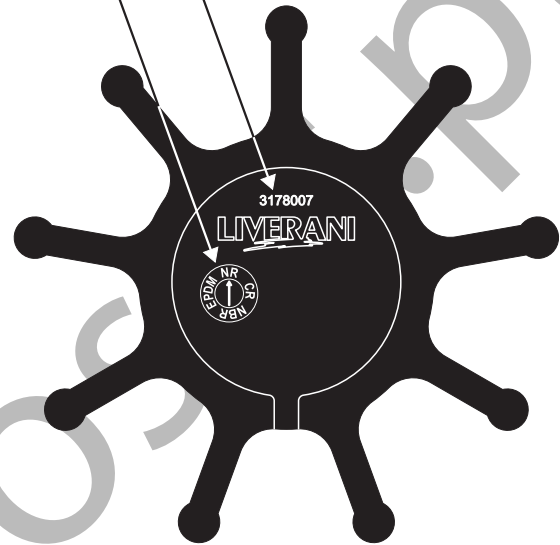

MINI 3/4"

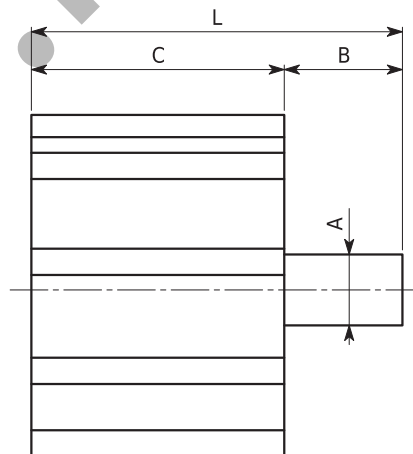

MIDEX 1"1/4 - MINOR 40 - MAJOR 60 - MAXI 80

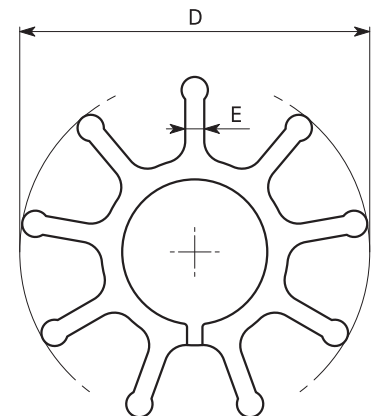

Tipo Type	A	B	C	D	E	L	Nr. pale Nr. blades
MINI 3/4"	Ø 12	-	29.6	Ø 56	4	29.6	8
MIDEX 1"1/4	Ø 24.8	35	52	Ø 66.5	5	87	8
MINOR 40	Ø 24.8	35	87	Ø 98	5.5	122	9
MAJOR 60	Ø 30	57	107	Ø 146	7	164	9
MAXI 80	Ø 30	44	144	Ø 196	10	188	9